



FEATURES

- Wide Input Voltage Range: 3.0V to 36V
- 410kHz Switching Frequency
- **3A** Output Current Capability
- Low Operating Quiescent Current: **30μA** (Typ.) From 12V_{IN} to 3.3V_{OUT}
- ±1.5% 1V Reference Over -40°C~125°C
- Peak Eff. **>95%** (Typ.) From 12V_{IN} to 5V_{OUT}
- Minimum On Time: **40ns** (Typ.)
- Internal Compensation
- Precision Enable
- Cycle by Cycle Current Limit and Hiccup When Overload or Short Circuit
- Thermal Shutdown and Auto Recovery
- AEC-Q100

APPLICATION

- Automotive System: Cockpit, ADAS
- Consumer systems: Robotic Vacuum Cleaner, Drone.
- Battery Powered System: Power Tools, Home Appliance, GPS Tracker etc.
- Industrial and Medical Power Supplies

DESCRIPTION

The AWK6943 is a high efficiency synchronous monolithic step-down switching regulator with integrated internal high-side and low-side MOSFETs. It provides up to 3A output current with peak current mode control for fast loop response. The AWK6943 operates over a wide input voltage range from 3.0V to 36V with only 30μA low quiescent current.

Standard features include thermal shutdown, UVLO, enable (EN) control and power good (PG) indicator. During the overload or output short circuit, the cycle by cycle current limit and hiccup protection are provided. Thermal shutdown provides reliable and fault-tolerant operation.

Device Information

DEVICE	PACKAGE	BODY SIZE(NOM)
AWK6943	QFN-8	3.00mm × 3.00mm

Typical Application

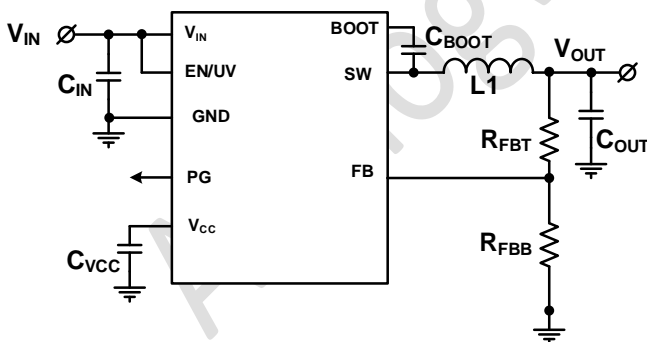

Fig.1 Schematic Diagram

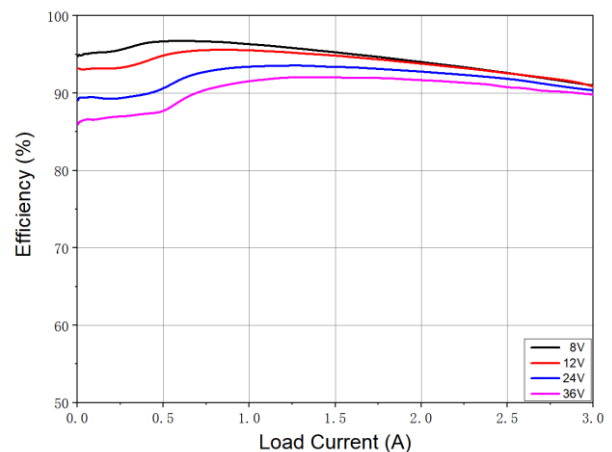

Fig.2 Efficiency vs. Output Current

Table of Contents

Features1

Application.....1

Description.....1

Typical Application1

Pin Configuration4

Pin Description.....4

ABSOLUTE MAXIMUM RATINGS4

RECOMMENDED OPERATING CONDITIONS5

ESD RATINGS.....5

ELECTRICAL CHARACTERISTICS5

FUNCTIONAL DIAGRAM7

Typical Characteristics8

PRODUCT OVERVIEW10

Feature Description10

 Light Load Operation10

 Soft-Start with Pre-Biased Capability10

 Over-Current Protection and Hiccup Mode10

 Low Drop-out Mode10

 Minimum On Time.....10

 Power Good11

APPLICATION12

 Setting Output Voltage12

 Inductor Selection.....13

 Output Capacitor Selection13

 Input Capacitor Selection13

 C_{FF} Capacitor Selection.....13

Bootstrap Capacitor Selection	14
VCC Capacitor Selection.....	14
EN Resistor Selection	14
APPLICATION WAVEFORMS.....	15
PCB LAYOUT GUIDELINES	18
PACKAGE INFORMATION.....	19
Package Top marking.....	19
Tape and Reel Box Information	19
Tape and Reel Information	20
Package Outlines	21
ORDERING INFORMATION.....	22
REVISION HISTORY.....	23

PIN CONFIGURATION

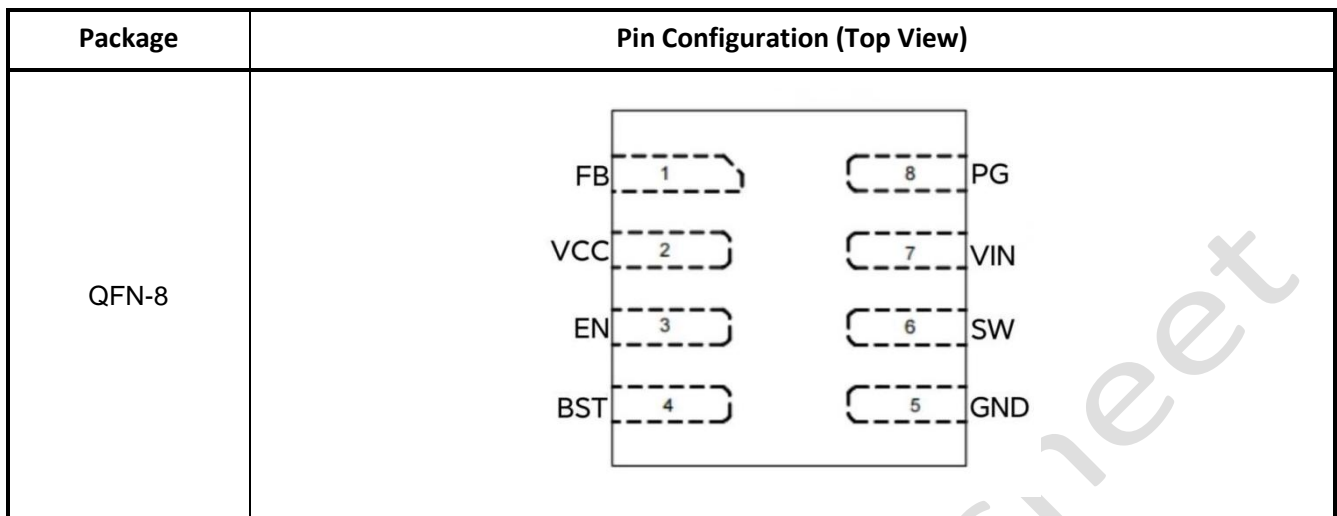

PIN DESCRIPTION

No.	Pin	Type ⁽¹⁾	Description
1	FB	I	Feedback Voltage
2	VCC	O	Internal Supply for Control Circuits
3	EN	I	Enable Input
4	BST	I/O	Bootstrap Supply Voltage
5	GND	G	Power Ground
6	SW	I/O	Switching Node Output
7	VIN	P	Input Voltage
8	PG	I/O	Power Good Signal

(1) G = Ground, I = Input, O = Output, P = Power

Table 1. AWK6943 QFN-8 Pin Description

ABSOLUTE MAXIMUM RATINGS

		Min	Max	Units
Input	VIN, EN to GND	-0.3	42	V
	FB to GND	-0.3	5.5	
	PG to GND	-0.3	6	
	BST to SW	-0.3	5.5	
Output	VCC to GND	-0.3	6	V
	SW to GND	-0.3	42	
T _J	Junction temperature	-40	150	°C
T _s	Storage temperature	-55	150	

RECOMMENDED OPERATING CONDITIONS

		Min	Max	Units
Buck Regulator	V _{IN}	3.0	36	V
	SW		36	
	FB	0	5	
Control	EN	0	36	V
	PG	0	5	
Output	V _{OUT}	0	24	V
T _J	Junction temperature	-40	125	°C

ESD RATINGS

Symbol	Definition	Value	Units
V _{ESD}	HBM	±2000	V
	CDM	±2000	

ELECTRICAL CHARACTERISTICS

Limits apply over the recommended operating junction temperature -40°C to +125°C, unless otherwise stated. Minimum and Maximum limits are specified through test, design or statistical correlation. Typical values represent the most likely parametric norm at T_J = 25°C, and are provided for reference purposes only. Unless otherwise stated the following conditions apply: V_{IN} = 12 V. V_{OUT} is converter output voltage.

Symbol	Parameter	Condition	Min	Typ	Max	Units
I _{SD}	Shutdown Supply Current	V _{EN} =0V			8	μA
I _Q	Non-Switching Quiescent Current	V _{FB} =1.05V			20	μA
R _{DS(on)_H}	High Side MOSFET ON Resistance			105	190	mΩ
R _{DS(on)_L}	Low Side MOSFET ON Resistance			65	135	mΩ
I _{LKG_SW}	Switch Leakage	V _{EN} =0V, V _{SW} =12V			1	μA
I _{LIMIT_H}	High Side MOSFET Current Limit ⁽¹⁾		3.5	4.5	5.8	A
I _{LIMIT_L}	Low Side MOSFET Current Limit ^{(1) (2)}		2.8			A
f _{sw}	Switching Frequency		350	410	470	kHz
f _{FB}	Fold-Back Frequency	V _{FB} <700mV	210	280	350	kHz

D _{MAX}	Maximum Duty Cycle	V _{IN} =V _{OUT} =12V, I _{OUT} =1A	96	98.5		%
T _{ON_MIN}	Min. Turn On Time ⁽²⁾			40		ns
V _{FB}	Feedback voltage		0.985	1.00	1.015	V
I _{FB}	Current into FB pin	V _{FB} =1V	-100		100	nA
V _{EN_H}	Enable High Threshold		1.185	1.235	1.285	V
V _{EN_L}	Enable Low Threshold		0.95	1.03	1.09	V
V _{EN_HYS}	Enable Hysteresis Threshold			205		mV
V _{EN_LKG}	Enable Pin Leakage Current	V _{EN} =2V		-0.6		nA
V _{IN_UV}	Under Voltage Lockout Thresholds	Rising Threshold		2.85	3.2	V
		Falling Threshold	2.2	2.65		V
		Hysteresis		200		mV
V _{CC}	Internal Power Supply	4V ≤ V _{IN} , I _{LOAD} =0mA	3.32	3.5	3.68	V
	V _{CC} Load Regulation	4V ≤ V _{IN} , I _{LOAD} =5mA		1.5	3	%
T _{SS}	Internal Soft-Start Time		2	5	9	ms
T _{SD}	Thermal Shutdown			165		°C
T _{SD_HYS}				15		°C
V _{PG_R}	Power Good Threshold Rising	% of V _{FB}	91	94	97	%
V _{PG_F}	Power Good Threshold Falling	% of V _{FB}	89	92	95	%
PG _{Vth_HYS}	PG Threshold Hysteresis	% of V _{FB}		2		%
t _{PG}	Power Good Glitch Filter Delay		40	130	160	μs
R _{PG}	PG Pull-Down Resistance	V _{EN} =4V		95	250	Ω
		V _{EN} =0V		85	200	
I _{LKG_PG}	PG Leakage Current				100	nA

(1) The current limit values in this table are tested, open loop, in production. They may differ from those found in a closed loop application.

(2) Derived from bench characterization. Not tested in production.

FUNCTIONAL DIAGRAM

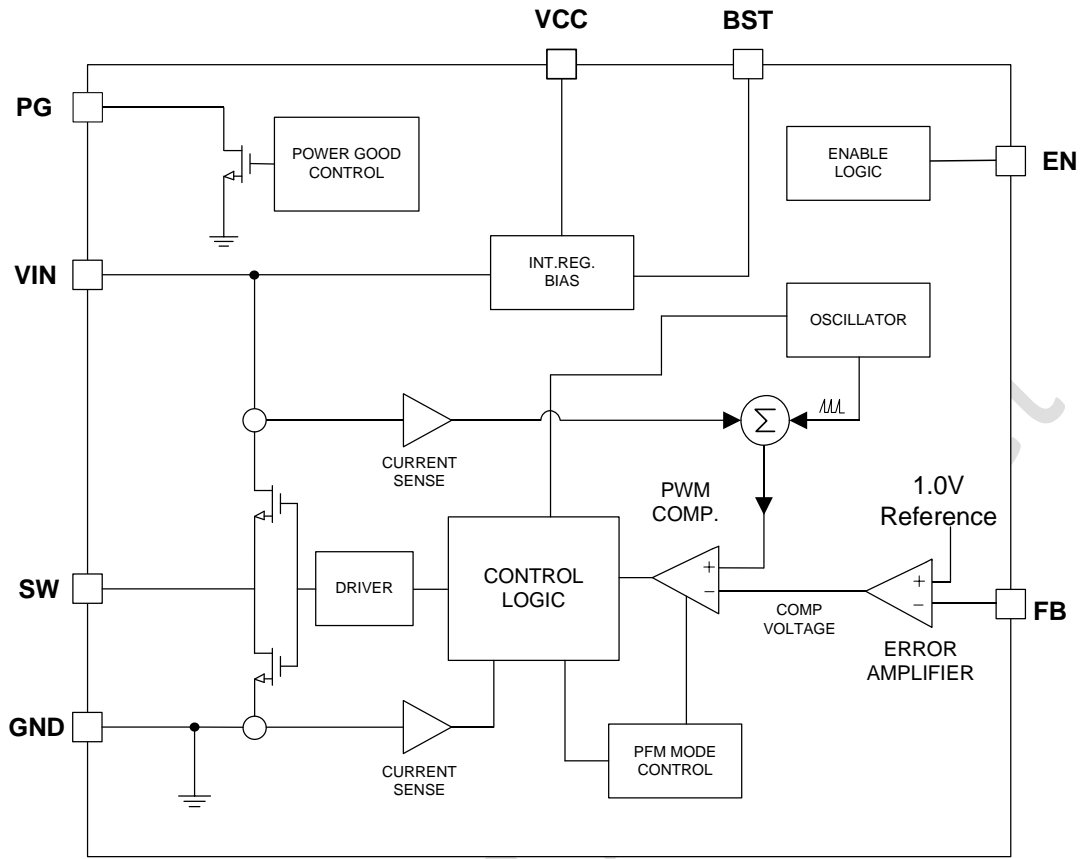

Fig.3 Functional Diagram

TYPICAL CHARACTERISTICS

Unless otherwise specified the following conditions apply: $V_{IN} = 12V$, $f_{SW} = 410kHz$, $L=10\mu H$, $C_{OUT} = 44\mu F$, $T_J = 25^\circ C$

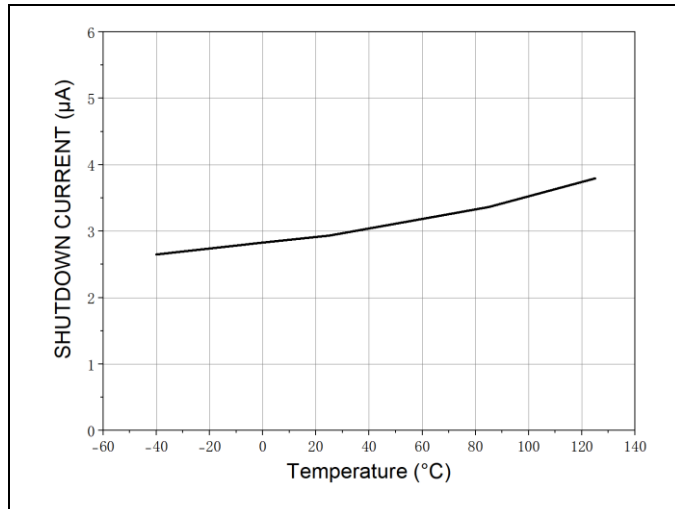

Fig.4 Shutdown Current VS. Junction Temperature

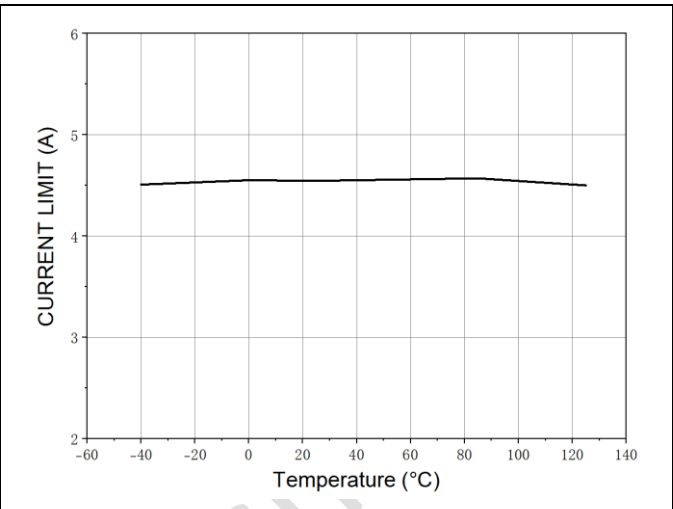

Fig.5 Current Limit VS. Junction Temperature at Duty = 40%

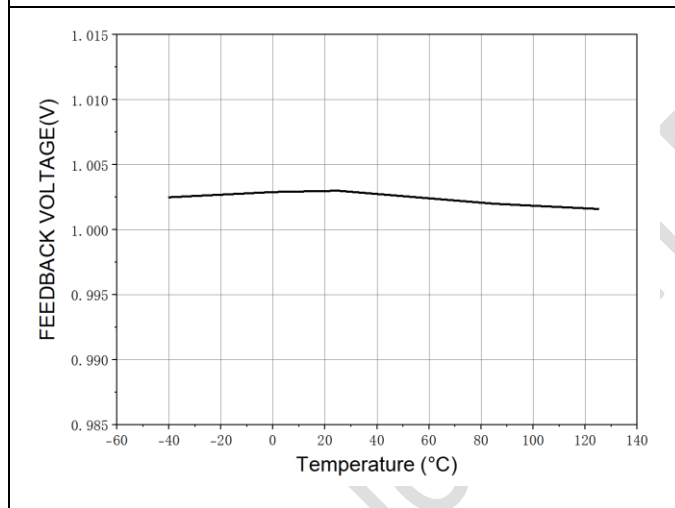

Fig.6 Feedback Voltage VS. Junction Temperature

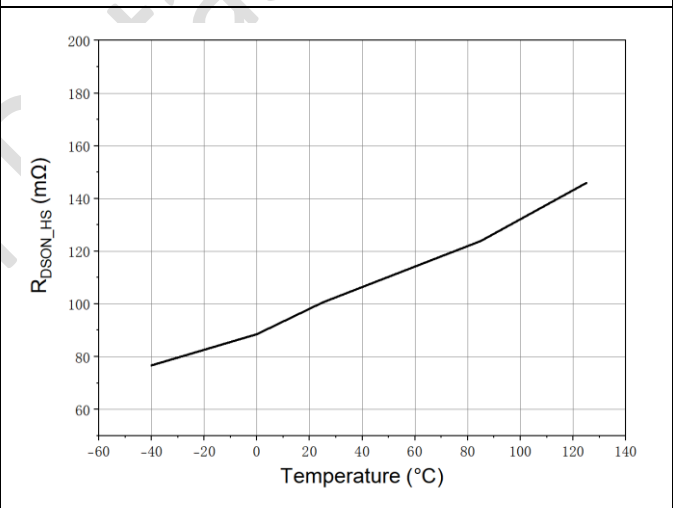

Fig.7 R_{DSON_HS} VS. Junction Temperature

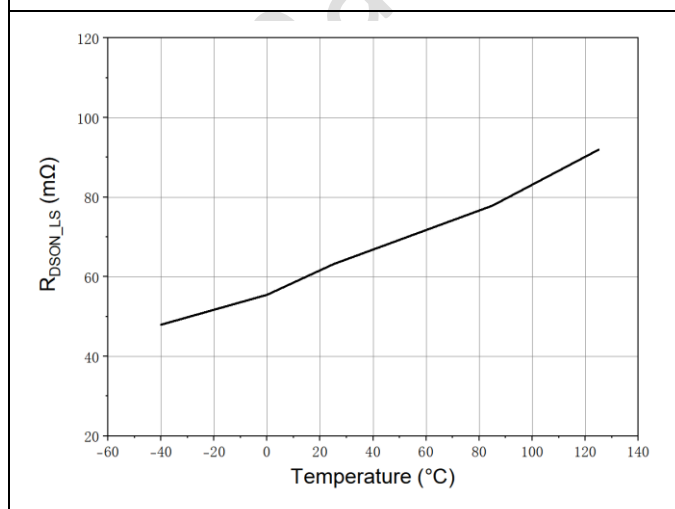

Fig.8 R_{DSON_LS} VS. Junction Temperature

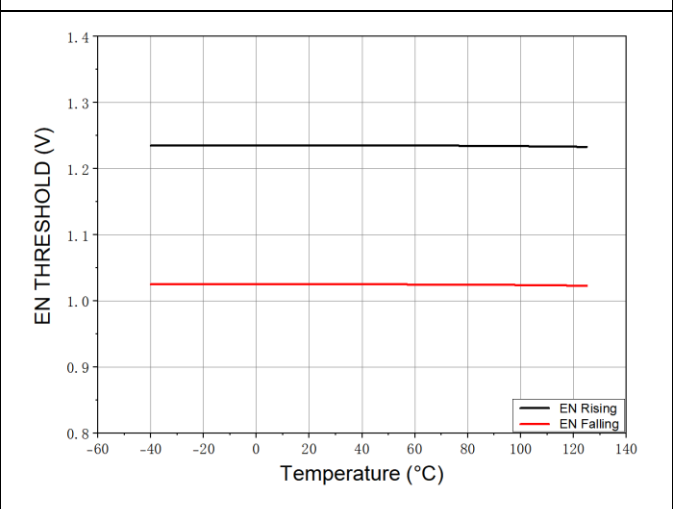

Fig.9 EN Threshold VS. Junction Temperature

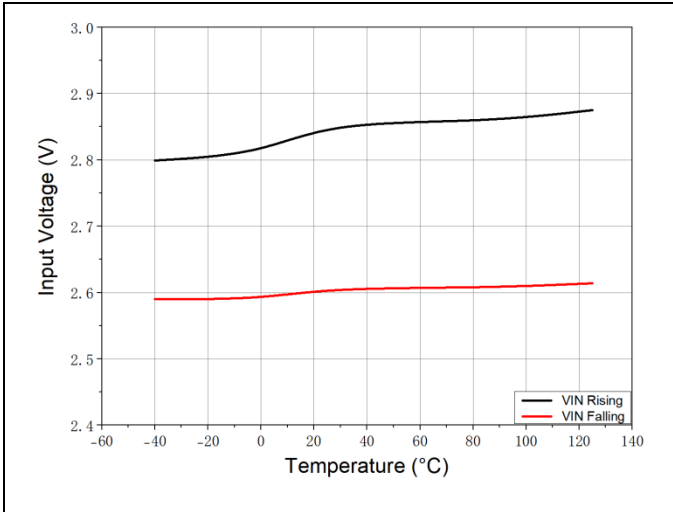

Fig.10 V_{IN} UVLO VS. Junction Temperature

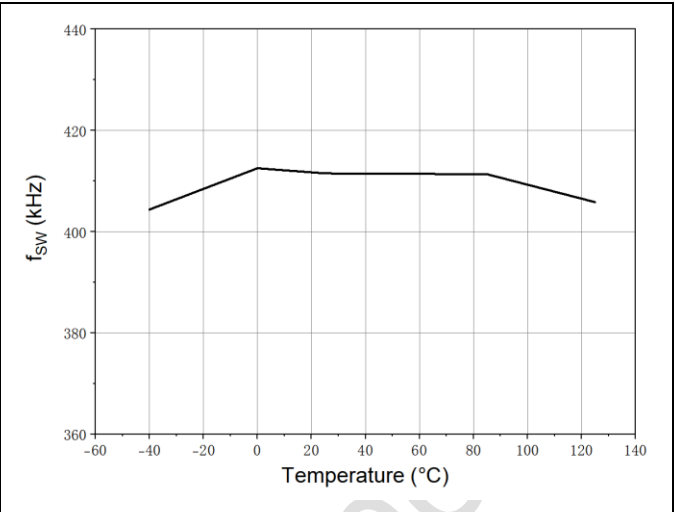

Fig.11 Switching Frequency VS. Junction Temperature

PRODUCT OVERVIEW

The AWK6943 is a synchronous, step-down, switching regulator with integrated high-side and low-side power MOSFETs. The AWK6943 can provide 3A of output current with very high efficiency from light load to full load. The AWK6943 features a wide input voltage from 3.0V to 36V, switching frequency 410 kHz. The internal soft start limits inrush current during power on. The AWK6943 also integrated compensation circuit inside the chip to simplify the loop design. Another highlighted feature is its very low operational quiescent current which makes it suitable for battery powered applications.

FEATURE DESCRIPTION

Light Load Operation

The AWK6943 utilizes advanced Pulse Frequency Modulation (PFM) control to improve efficiency in light load working condition. When the loading current decreases, the device approaches discontinuous conduction mode first and the COMP voltage decreases accordingly. The low-side power switch is turned off when the zero current detection is triggered to improve system efficiency. When the COMP voltage drops to the low clamped threshold voltage, the device will skip pulse and decrease switching frequency by extend the non-switching period. During this period, the output voltage decreases due to load current or capacitor discharge. The high-side power switch will resume to turn on once the COMP voltage is higher than the threshold. The device will try to obtain few switching pulses with minimum peak inductor current to reduce the output ripple and the COMP voltage will drop to the clamped value again and trigger another non-switching period.

Soft-Start with Pre-Biased Capability

The AWK6943 implements a soft-start circuits to prevent the inrush current during start up. The soft start time is fixed internally. When the start-up period begins, the output voltage slowly ramps up. The AWK6943 also supports a monotonic start-up with pre-biased loads. If output voltage is pre-biased to a certain value during start-up, the device disables switching for both high-side and low-side power switches until soft-start reference voltage exceeds the feedback voltage.

Over-Current Protection and Hiccup Mode

The AWK6943 has cycle-by-cycle over current limit when the inductor current peak value exceeds the set current limit threshold. If, during current limit, the voltage on the FB input falls below about 0.5 V due to a short circuit, the device enters into hiccup mode. In this mode, the device stops switching for about 30 ms and then goes through a normal re-start with soft start. If the short-circuit condition remains, the device runs in current limit for about 5 ms (typical) and then shuts down again. This cycle repeats as long as the short circuit-condition persists. This mode of operation helps reduce the temperature rise of the device during a hard short on the output. The output current is greatly reduced during hiccup mode. Once the output short is removed and the hiccup delay is passed, the output voltage recovers normally.

Low Drop-out Mode

As the duty cycle is increasing, where the input voltage approaches the output voltage level, the required off time of high-side power switch will approach its minimum off time. When the minimum off time is reached, the AWK6943 will automatically extend the high-side on time and reduce the switching frequency. The device can realize 98.5% max duty cycle in drop-out condition. In this condition, the dropout voltage difference between input and output is influenced by the on-resistance of power switch, the DCR of power inductor, and the maximum duty cycle achieved.

Minimum On Time

As the duty cycle is decreasing, where the conversion ratio is very low, the required on time of high-side power switch will approach its minimum on time. The AWK6943 features typical 40ns ultra-low minimum on time and can support smaller duty cycle for high frequency power systems. Also, the device can automatically reduce the switching frequency, when the minimum on time is reached.

Power Good

The device employs an open-drain output PGOOD signal to check whether the output voltage is operating within the normal range. The external pull up voltage resource is recommended to be less than 5V (such as VCC) with a 100k Ω resistor. Once the feedback voltage is within the 92% and 107% of internal reference voltage, the PGOOD pull-down will be disabled and pulled up by the externally resistor. Once the feedback voltage is lower than 92% or greater than 107% of internal reference voltage, the PGOOD will be pulled low. To prevent glitching both the upper and lower thresholds include about 2% of hysteresis. Also, if UVLO, over temperature protection or EN pin is pulled low, the PGOOD will be pulled low accordingly.

Analogwin Datasheet

APPLICATION

Fig.12 shows a typical application circuit for the AWK6943. Thanks to the high integration in the AWK6943, the application circuit based on AWK6943 only need input capacitor, output capacitor, output inductor and feedback resistors which are needed to be selected based on applications specifications. Table 2 shows some typical external component values.

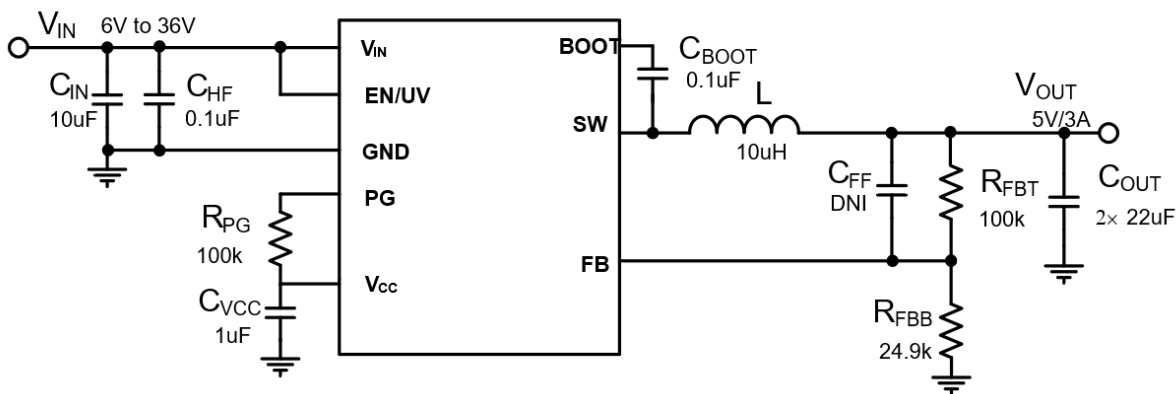

Fig.12 Typical Application Circuit (410kHz)

f _{sw} (kHz)	V _{OUT} (V)	L(μH)	C _{OUT} (RATED CAPACITANCE)	R _{FBT} (kΩ)	R _{FBB} (kΩ)	C _{IN} +C _{HF}	C _{BOOT}	C _{VCC}	C _{FF}
410	3.3	10	2*22μF	100	43	10μF+100nF	100nF	1uF	DNI
410	5	10	2*22μF	100	24.9	10μF+100nF	100nF	1uF	DNI

Table.2 Typical External Component Values

Setting Output Voltage

The external feedback resistors connected to FB sets the output voltage. The feedback resistors value can be calculated with the below equation.

$$R_{FBB} = \frac{V_{REF}R_{FBT}}{V_{OUT} - V_{REF}}$$

While R_{FBT}=100kΩ, V_{REF}=1V, V_{OUT}=5V

Calculate R_{FBB}=24.9kΩ

Inductor Selection

For higher efficiency, choose an inductor with a lower DC resistance. A larger-value inductor results in less ripple current and a lower output ripple voltage, but also has a larger physical size, higher series resistance, and lower saturation current. A good rule for determining the inductor value is to allow the inductor ripple current to be approximately 20% to 40% of the maximum load current. The minimum inductance value can be calculated with the below equation.

$$L_{MIN} = \frac{V_{OUT}(1 - D)}{f_{SW} \times \Delta I_L}$$

While $V_{OUT}=5V$, $f_{SW}=410kHz$, $\Delta I_L=30\% \times 3A=0.9A$, $D=5V/12V=0.417$
 Calculate $L=10\mu H$.

Output Capacitor Selection

The output capacitor maintains the DC output voltage. Ceramic, tantalum, or low ESR electrolytic capacitors are recommended. For best results, use low ESR capacitors to keep the output voltage ripple low. The output voltage ripple can be estimated with equation. Generally, required the output voltage ripple is less than 1% of the output voltage.

$$\Delta V_{OUT} = \frac{V_{OUT} \times (1 - D)}{8 \times f_{SW}^2 \times L \times C_{OUT}}$$

Input Capacitor Selection

The input capacitor can be electrolytic, tantalum, or ceramic. When using electrolytic or tantalum capacitors, add a small, high-quality ceramic capacitor (like X7R,C0G etc.) as close to the IC as possible. When using ceramic capacitors, ensure that they have enough capacitance to provide a sufficient charge to prevent excessive voltage ripple at the input. From the below equation, can easily calculate the input voltage ripple. Generally, required the input voltage ripple is less than 10% of the input voltage.

$$\Delta V_{IN} = \frac{I_O \times D \times (1 - D)}{f_{SW} \times C_{IN}}$$

CFF Capacitor Selection

When some cases need improvement of load transient response or the margin of loop-phase, a feedforward capacitor can be used across R_{FBT} , especially when values of $R_{FBT} > 1000k\Omega$ are used. The minimum capacitance value can be calculated with the below equation

$$C_{FF} \leq \frac{C_{OUT} \times V_{OUT}}{110 \times R_{FBT} \times \sqrt{\frac{R_{FBB}}{R_{FBT} + R_{FBB}}}}$$

Bootstrap Capacitor Selection

A bootstrap capacitor connected between the BOOT pin and the SW pin. This capacitor stores energy that is used to supply the gate drivers for the internal MOSFETs. A ceramic capacitor of 0.1uF and 16V voltage rating is required.

VCC Capacitor Selection

The VCC pin is the output of the internal LDO used to supply the control circuits of the converter. This output requires a ceramic capacitor connected from VCC to GND for proper operation. It is highly recommended placing a ceramic capacitor of 1uF and 16V voltage rating. In general, avoid loading this output with any external circuitry. However, this output can be used to supply the pullup for the PGOOD function. The nominal output voltage on VCC is 3.5V. Do not short this output to ground or any other external voltage. Also, if over temperature protection or EN pin is pulled low, the VCC pin output will be low.

EN Resistor Selection

The AWK6943 has undervoltage lockout feature with default rising threshold of 2.85 V. It can be adjusted by using EN pin with external resistor divider. The UVLO threshold integrates a 200mV hysteresis to make a desired hysteresis for input voltage.

V_{UVLO_R} is the desired system level undervoltage protection rising threshold voltage, V_{UVLO_F} is the desired system level undervoltage protection falling threshold voltage. The R_{ENT} and R_{ENB} value can be calculated with the below equation

$$V_{UVLO_R} = \left(\frac{R_{ENT}}{R_{ENT} + R_{ENB}} \right) \times V_{ENR}$$

$$V_{UVLO_F} = \left(\frac{R_{ENT}}{R_{ENT} + R_{ENB}} \right) \times (V_{ENR} - 0.2)$$

APPLICATION WAVEFORMS

Unless otherwise specified the following conditions apply: $V_{IN} = 12V$, $V_{OUT} = 5V$, $f_{SW} = 410kHz$, $L = 10\mu H$, $C_{OUT} = 44\mu F$, $T_J = 25^\circ C$.

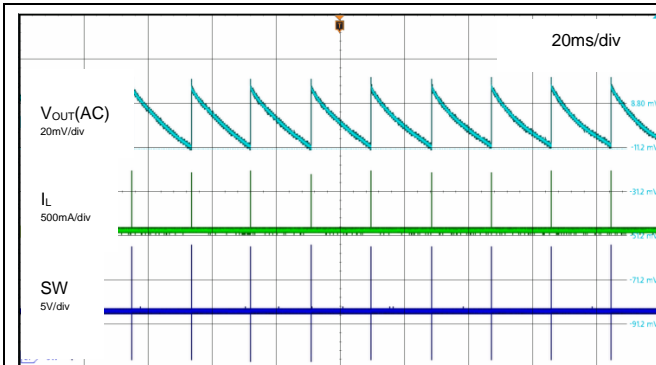

Fig.13 Steady State at $I_{LOAD}=0A$

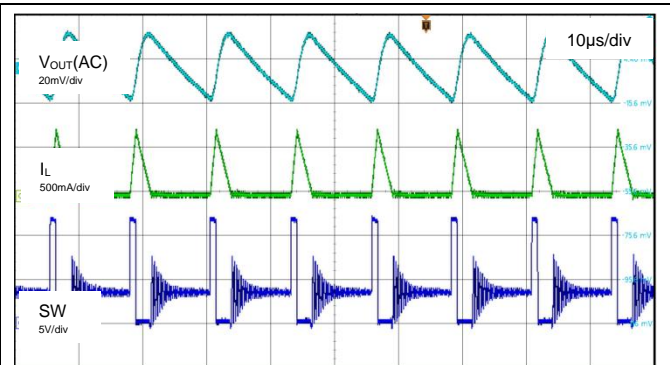

Fig.14 Steady State at $I_{LOAD}=100mA$

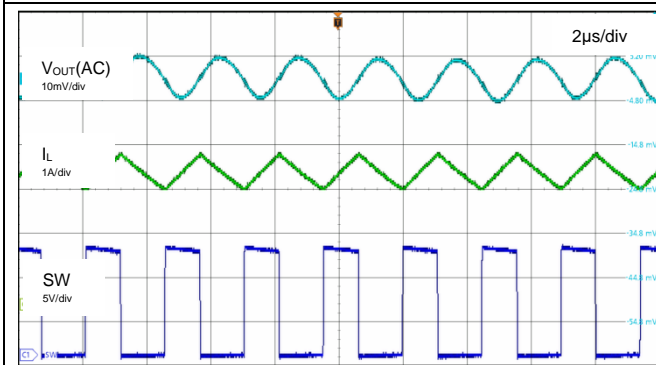

Fig.15 Steady State at $I_{LOAD}=3A$

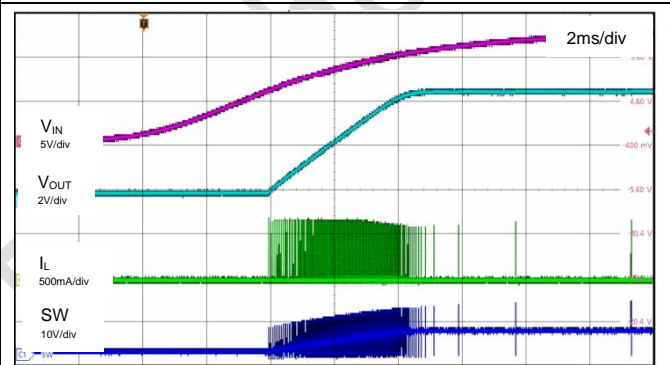

Fig.16 Startup through V_{IN} at $I_{LOAD}=0A$

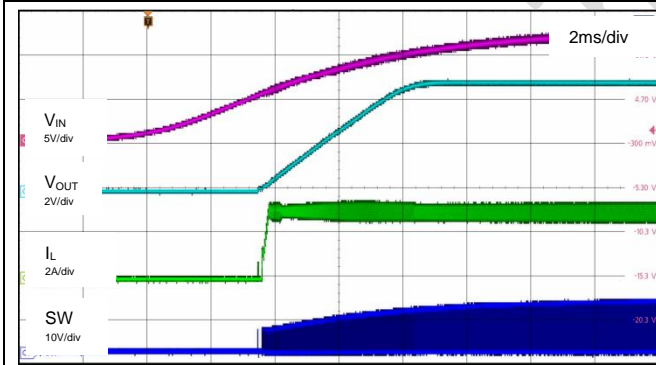

Fig.17 Startup through V_{IN} at $I_{LOAD}=3A$

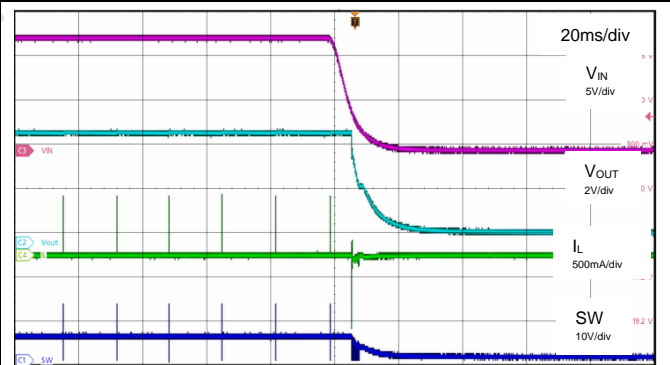

Fig.18 Shutdown through V_{IN} at $I_{LOAD}=0A$

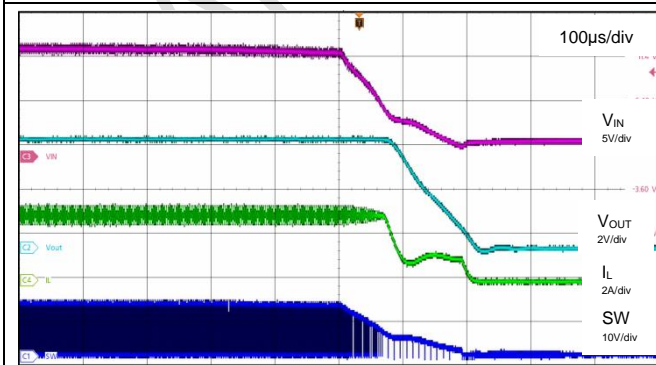

Fig.19 Shutdown through V_{IN} at $I_{LOAD}=3A$

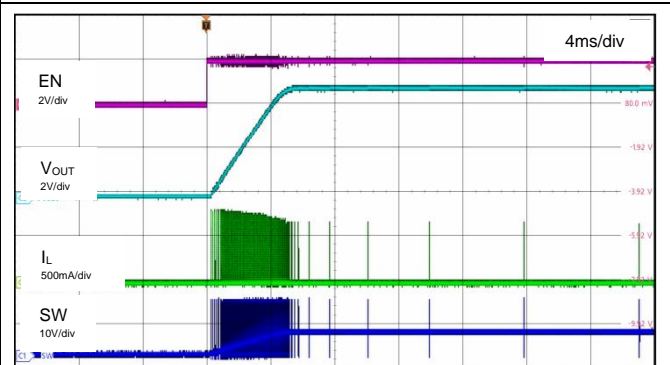

Fig.20 Startup through EN at $I_{LOAD}=0A$

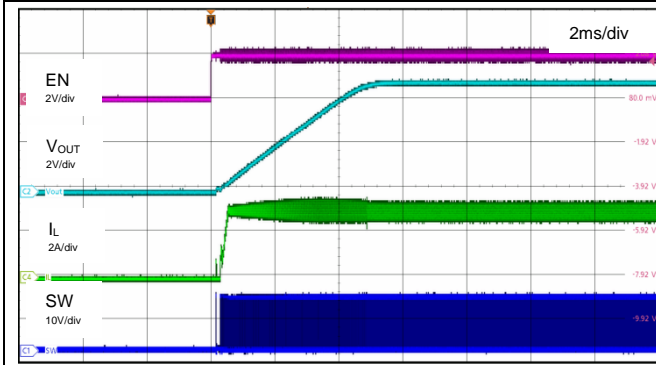

Fig.21 Startup through EN at $I_{LOAD}=3A$

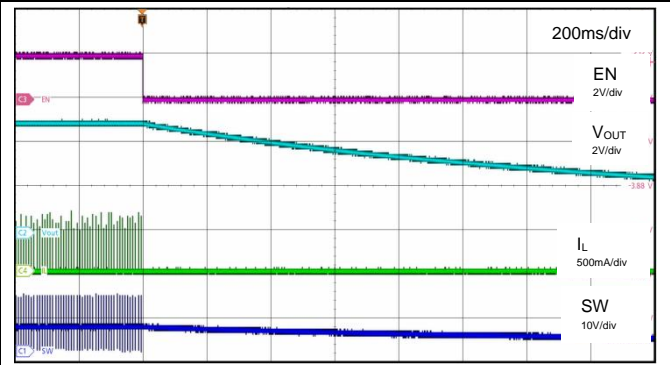

Fig.22 Shutdown through EN at $I_{LOAD}=0A$

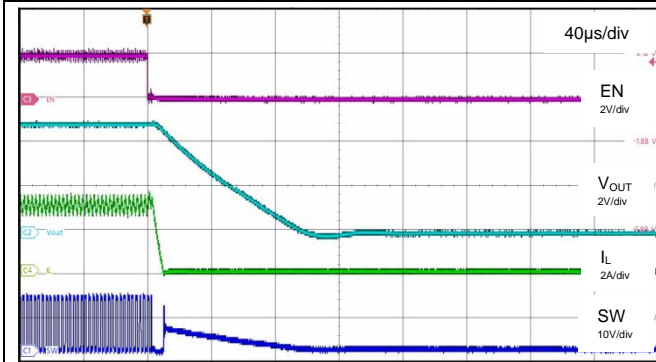

Fig.23 Shutdown through EN at $I_{LOAD}=3A$

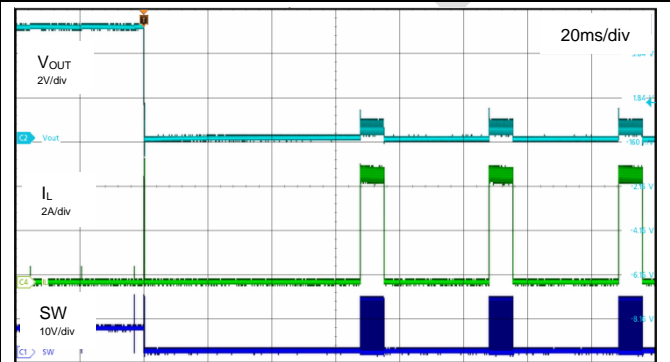

Fig.24 Short Circuit Protection at $I_o=0A$

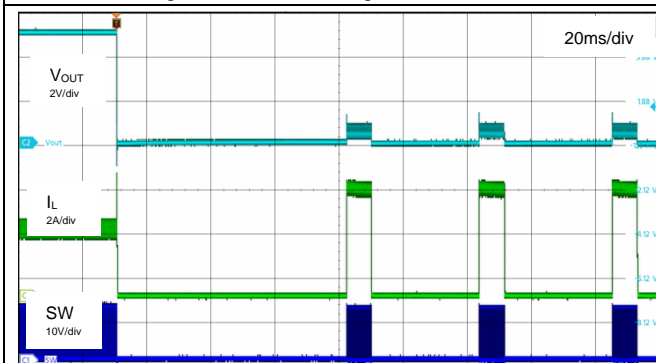

Fig.25 Short Circuit Protection at $I_o=3A$

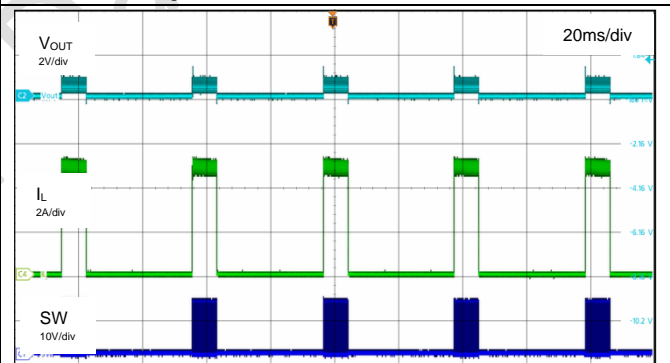

Fig.26 Short Circuit Steady

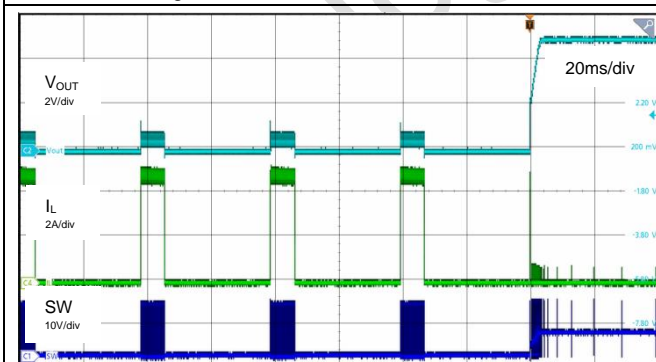

Fig.27 Short Circuit Recovery at $I_o=0A$

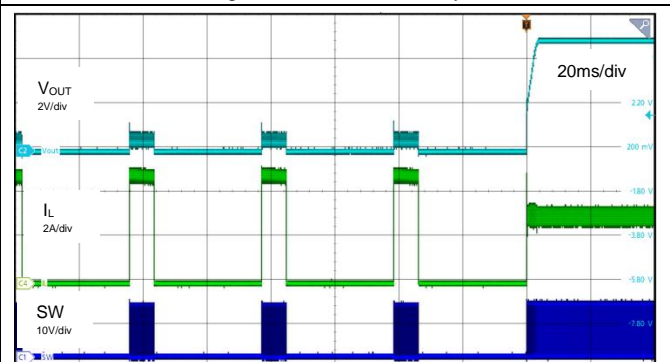

Fig.28 Short Circuit Recovery at $I_o=3A$

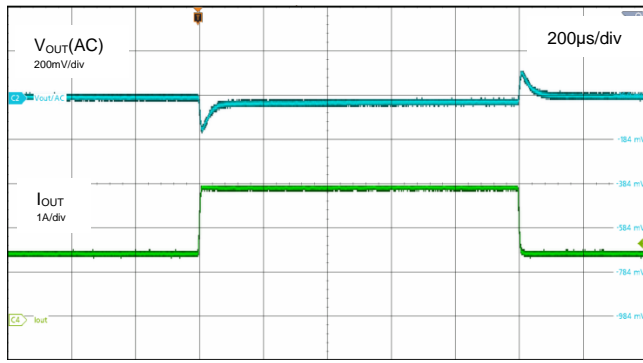

Fig.29 Load Transient at I_{LOAD} from 1.5A to 3A, 1.6A/µs

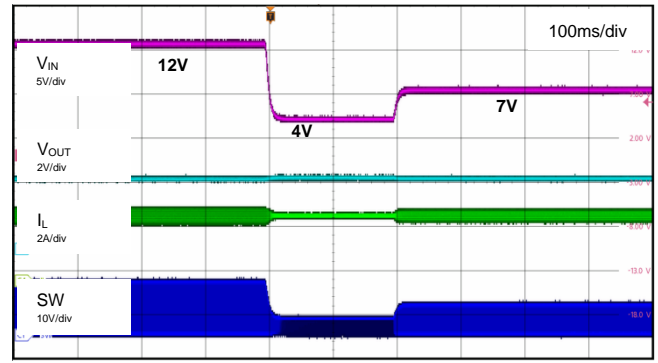

Fig.30 Cold-Crank at $V_{OUT}=3.3V$, $I_{OUT}=3A$

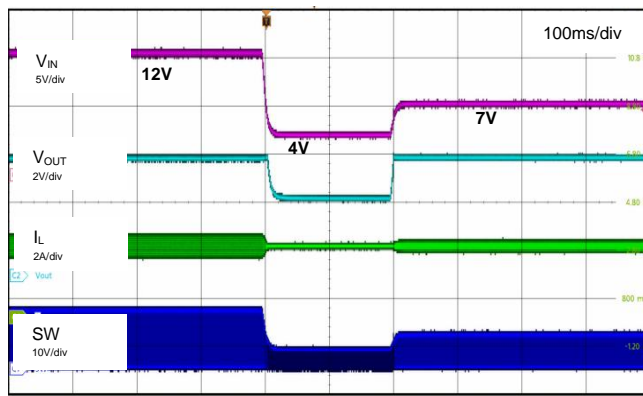

Fig.31 Cold-Crank at $V_{OUT}=5V$, $I_{OUT}=3A$

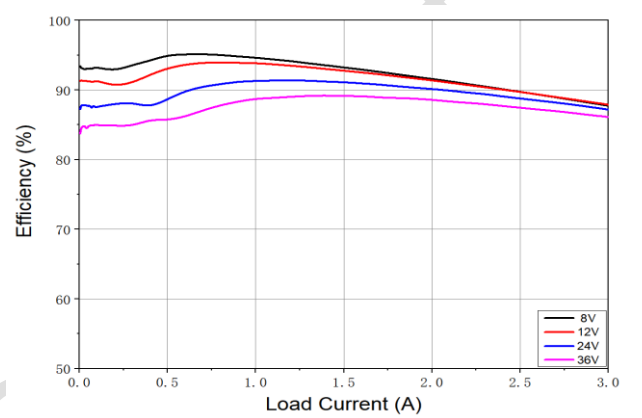

Fig.32 Efficiency VS. Load Current at $V_{OUT}=3.3V$

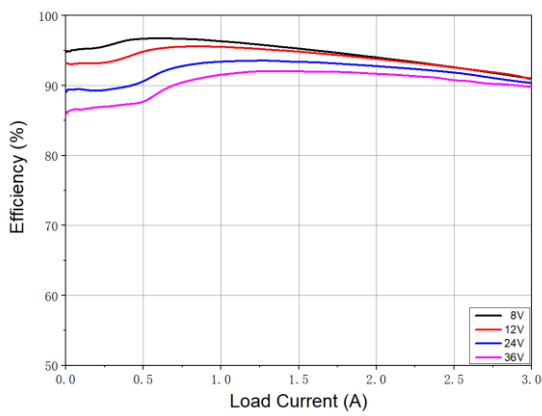

Fig.33 Efficiency VS. Load Current at $V_{OUT}=5V$

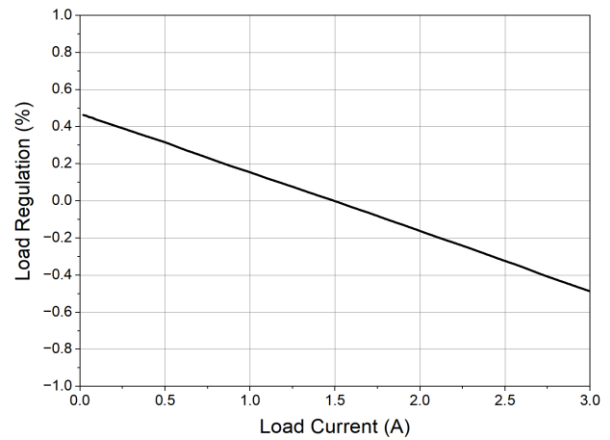

Fig.34 Load Regulation VS. Load Current at $V_{IN}=12V$

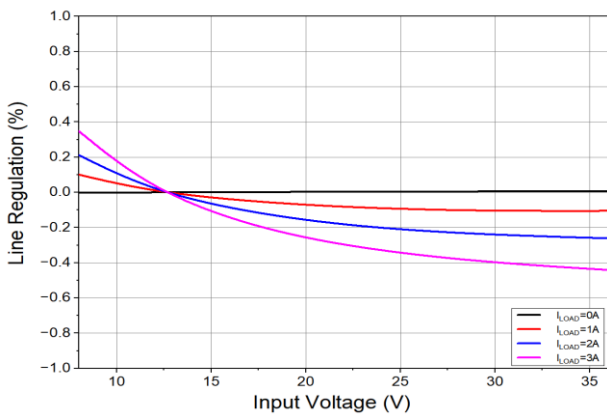

Fig.35 Line Regulation VS. Input Voltage at $V_{OUT}=5V$

PCB LAYOUT GUIDELINES

PCB layout is critical for stable operation of switching regulator AWK6943, especially for thermal design and EMI design. For best results, please refer to Fig. 36 and follow the guidelines below.

1. Place a low ESR ceramic capacitor as close to VIN pin and the ground as possible.
2. Make sure top switching loop with power have lowest impedance of grounding.
3. Use a large ground plane to connect to GND directly. And add vias near GND.
4. Output inductor should be placed close to the SW pin to minimize the SW area.
5. The FB terminal is sensitive to noise so the feedback resistor should be located as close as possible to the IC.
6. Keep the connection of the input capacitor and VIN as short and wide as possible.

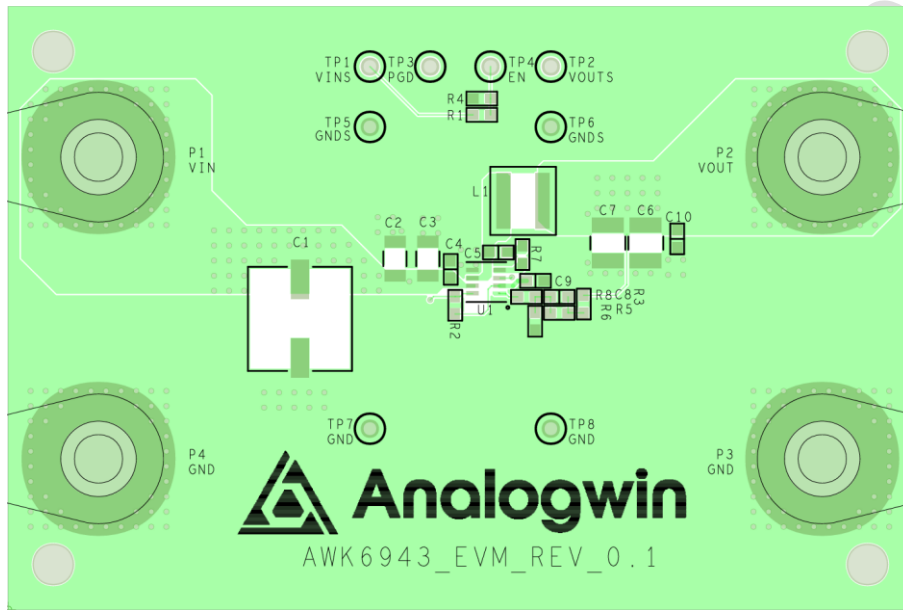

Fig.36 Layout Example

PACKAGE INFORMATION

Package Top marking

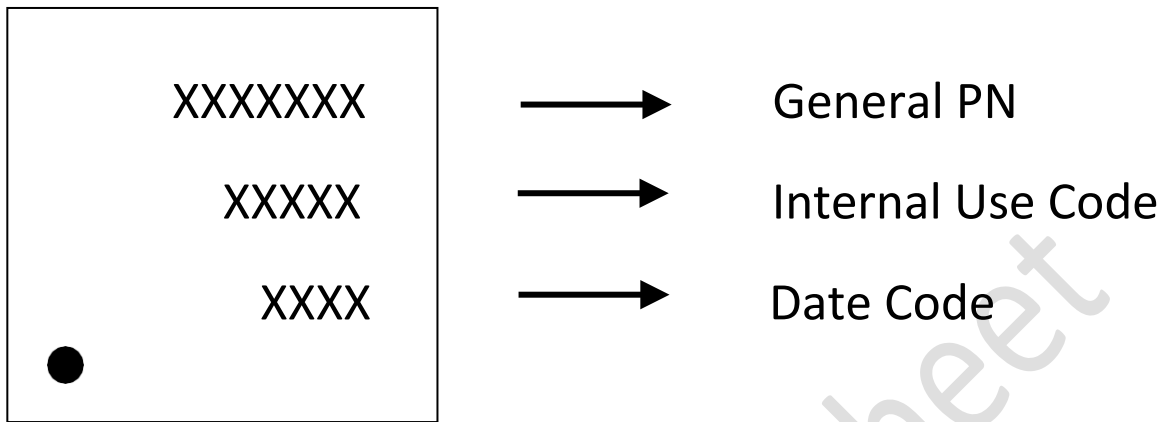

Fig.37 Package Top Marking

Tape and Reel Box Information

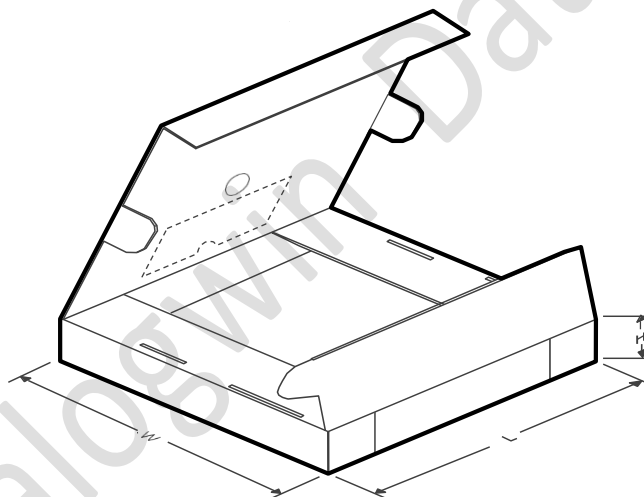

Fig.38 Tape and Reel Box Information

DEVICE	PACKAGE TYPE	PACKAGE DRAWING	PINS	SPQ	LENG (mm)	WIDTH (mm)	HEIGHT(mm)
AWK6943	QFN-8	TE	8	3000	320.0	320.0	48.0

Tape and Reel Information

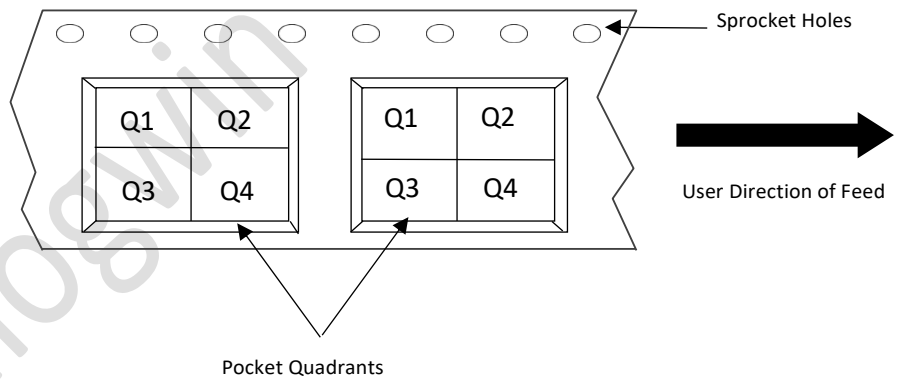
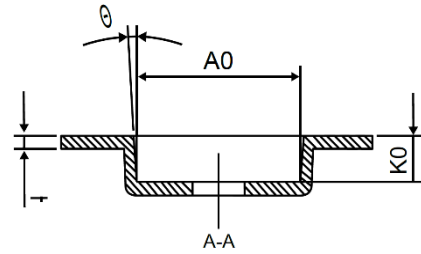
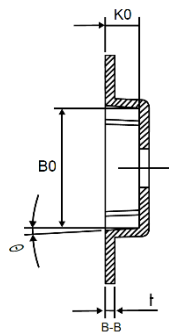
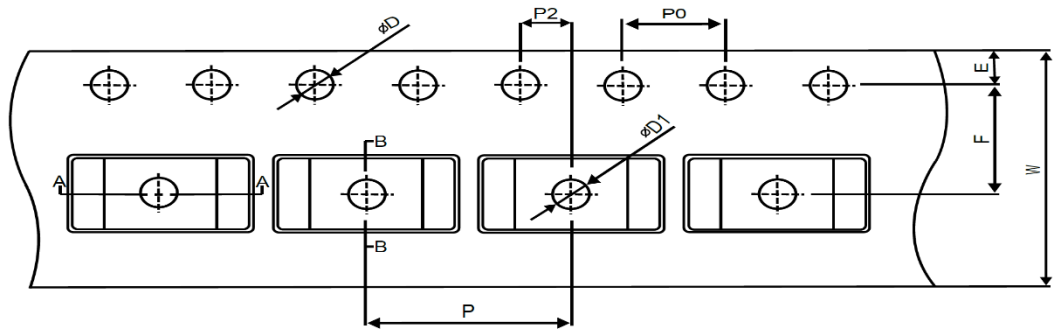

Fig.39 TAPE and Reel Information

DIMENSIONS AND PIN1 ORIENTATION

Device	Package Type	A0 (mm)	B0 (mm)	K0 (mm)	P (mm)	P0 (mm)	W (mm)	Pin1 Quadrant	Quantity
AWK6943	QFN-8	3.30	3.30	1.10	8.00	4.00	12.00	Q1	3000

All dimensions are nominal

Package Outlines

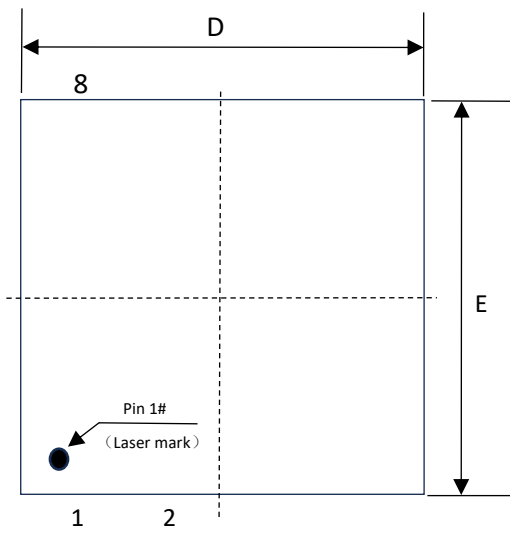

Top VIEW

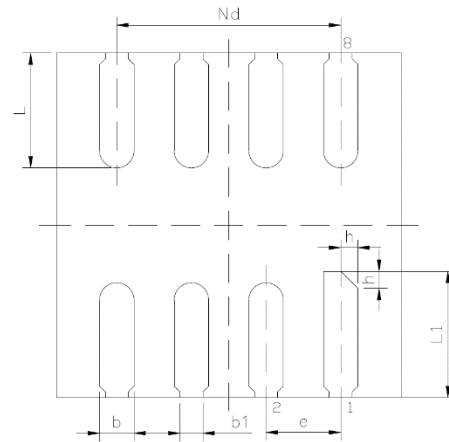

BOTTOM VIEW

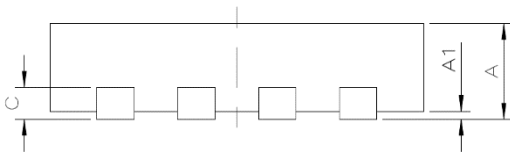

SIDE VIEW

SYMBOL	MILLIMETER		
	MIN	NOM	MAX
A	0.70	0.75	0.80
A1	0.00	0.02	0.05
b	0.25	0.30	0.35
b1	0.20REF		
c	0.203REF		
D	2.90	3.00	3.10
e	0.65BSC		
Nd	1.95BSC		
E	2.90	3.00	3.10
e	0.65BSC		
L	0.90	1.00	1.10
L1	1.00	1.10	1.20
h	0.10	0.15	0.20

Fig.40 QFN-8 Package

ORDERING INFORMATION

Device	Order Part No.	Frequency	Package	QTY
AWK6943	AWK6943ABTER	410kHz	QFN-8 Pb-Free	3000/Reel

Analogwin Datasheet

REVISION HISTORY

DATE	REVISION	NOTES
Sep. 2024	1.0	Initial release
Oct. 2024	1.1	<ol style="list-style-type: none"> 1. Update Efficiency chart (Page. 1/17) 2. Update R_{DSON_HS}/R_{DSON_LS} chart (Page. 8) 3. Delete Sleep Current and PG Threshold chart (Page. 8/9)
Nov. 2024	1.2	<ol style="list-style-type: none"> 1.Update Device Information (Page. 1) 2. Add definition of PIN characteristics (Page. 4) 3.Update Order Part No. (Page. 22)
Dec. 2024	1.3	<ol style="list-style-type: none"> 1. Add AEC-Q100 certification description to Feature items (Page. 1) 2. Add Automotive System Application (Page. 1) 3. Update CDM values in ESD RATING (Page. 5) 4. Recommended operating junction temperature for limit values Change to 40°C to 125°C in the EC Table (Page. 5) 5. Update the lower limit value of Low Side MOSFET Current Limit (Page. 5) 6. Update VIN-UV Rising Threshold upper limit value (Page. 6)